

## ATP1006-2 Time Switch



(The time switch timing can be set second.)

### 1. Function and Scope

ATP1006-2 time switch (hereinafter referred to as “time switch”) is applicable for regularly controlling switch-on and off of street lamps, advertising light boxes and other equipments in automatic control circuit with AC frequency of 50Hz, rated control power voltage of 220V at most and rated working current of 3A at most.

### 2. Model and Its Meaning: ATP1006-2

### 3. Normal Operating Condition and Installation Condition

3.1 Ambient air humidity:  $-25^{\circ}\text{C}\sim+40^{\circ}\text{C}$ , and the average temperature is no more than

$+35^{\circ}\text{C}$  in 24h.

3.2 Altitude: no more than 2,000m.

3.3 Humidity: the relative air humidity of the installation site shall be no more than 50% when the maximum temperature is  $+40^{\circ}\text{C}$ , while it can be higher under lower temperature. Special measures shall be taken for the condensation occasionally formed due to temperature change.

3.4 Pollution level: 3.

3.5 In the medium with no explosion hazard and no gas that is enough to corrode metal and destroy the insulation and the place shall not have severe conductive dust.

3.6 In the place where is provided with anti-snow and anti-rain equipment but not be full of water steam.

3.7 In the place without significant shake, shock and vibration.

3.8 Installation class: II.

3.9 Transport and Storage Conditions:  $-25^{\circ}\text{C}$  to  $+55^{\circ}\text{C}$ .

3.10 Power voltage change scope: 85%~110% rated voltage.

3.11 Protection grade: IP20.

### 4 Main Technical Parameters

4.1 Rated control power voltage: AC (50Hz): 220V.

4.2 Conventional thermal current: (Ith) 16A.

4.3 Category of the auxiliary circuit: AC-15.

4.4 Rated working current (Ie): AC-15 220V 3A.

4.5 Timing error:  $\leq 1\text{s/d}$ .

4.6 Time control scope: 1sec~168h.

4.7 Mechanical life:  $\geq 30,000$  times.

4.8 Electric endurance:  $\geq 10,000$  times.

4.9 Installation method: Device installed, guide tracked.

4.10 Anti-interference tolerance sees Table 1.

Table 1 Anti-interference Tolerance

Item	Severity
Static discharge tolerance	$8 \times (1 \pm 10\%)$ KV (air discharge)
Electromagnetic radiation tolerance	Test field strength $10 \times (1 \pm 10\%)$ V/m
Fast transient tolerance	For power line: $2 \times (1 \pm 10\%)$ KV, duration 1min
Surge (shock) tolerance	For power line: $1 \times (1 \pm 10\%)$ KV
RF conduction tolerance	Open circuit test voltage 10V, frequency scope 150kHz~80MHz
Voltage sage tolerance	Sag 30% in half a cycle, sag 60% in 5 cycles and 50 cycles, sag 100% in 250 cycles

5 Outline, Installation Dimension and Wiring Method

5.1 Outside dimension and installation dimension see Figure 1.

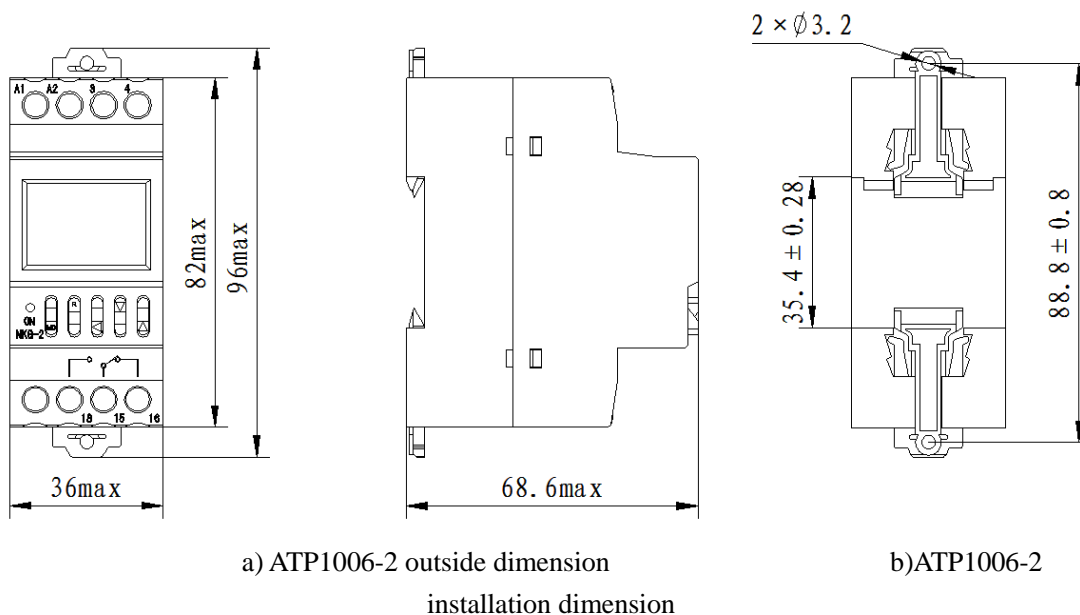

Figure 1 Outside dimensions and installation dimensions of ATP1006-2

5.2 Wiring method

5.2.1 Direct control method

Power of the controlled appliance is supplied in single-phase, of which the working current is no more than the rated value of this switch. Direct control method may be adopted, wiring method see Figure 2; for light load with great starting current impact, please adopt AC contactor expansion control method.

5.2.2 Single-phase expansion method

The controlled appliance is power supplied in single-phase, of which the working current exceeds the rated value of this switch. Please adopt AC contactor expansion control method, see Figure 3.

5.2.3 Three-phase operating method

Power of the controlled appliance is supplied in three-phase, so external AC contactor is required hereof.

a) The coil voltage of the controlled contactor is AC 220C 50Hz, so its wiring method sees Figure 4;

b) The coil voltage of the controlled contactor is AC 380V 50Hz, so its wiring method sees Figure 5.

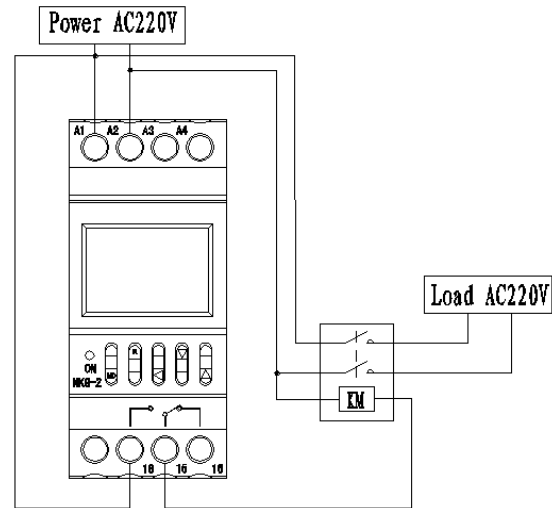
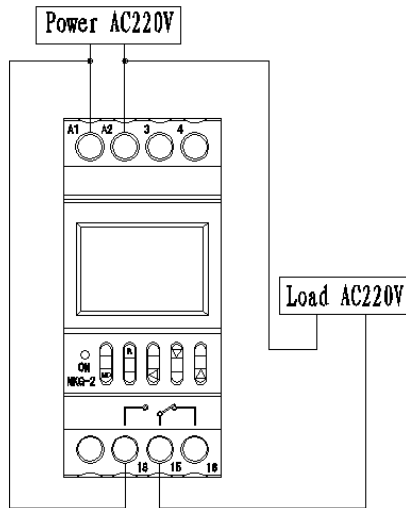

Figure 2 Direct single-phase controlled wiring diagram

Figure 3 Single-phase expansion controlled wiring diagram

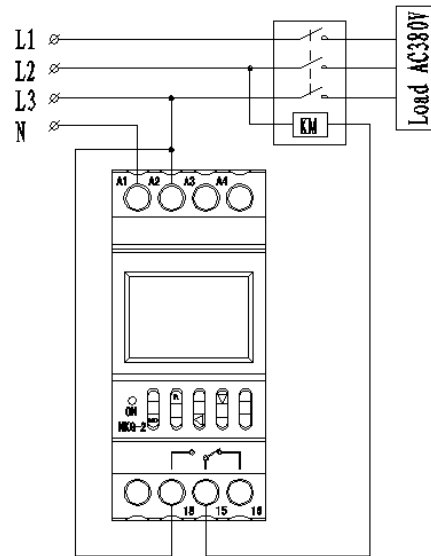
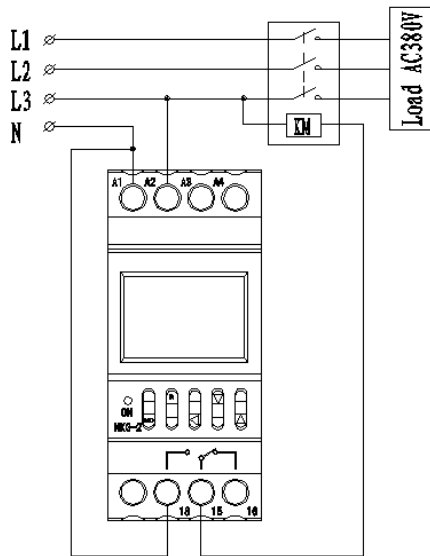

Figure 4 Three-phase controlled wiring diagram (220V for contactor coil)

Figure 5 Three-phase controlled wiring diagram (3800V for contactor coil)

## 6 Setting and Use

This product panel is set with five buttons, namely “MD (mode)”, “R (recall)”, “◀ (left)”, “▼ (-)” and “▲ (+)”, so it can adjust correspondingly hour (h), minute (min) and date; if there is some operating indication, time switch may be controlled manually or automatically.

### 6.1 Setting process for time switch parameters (see Figure 6)

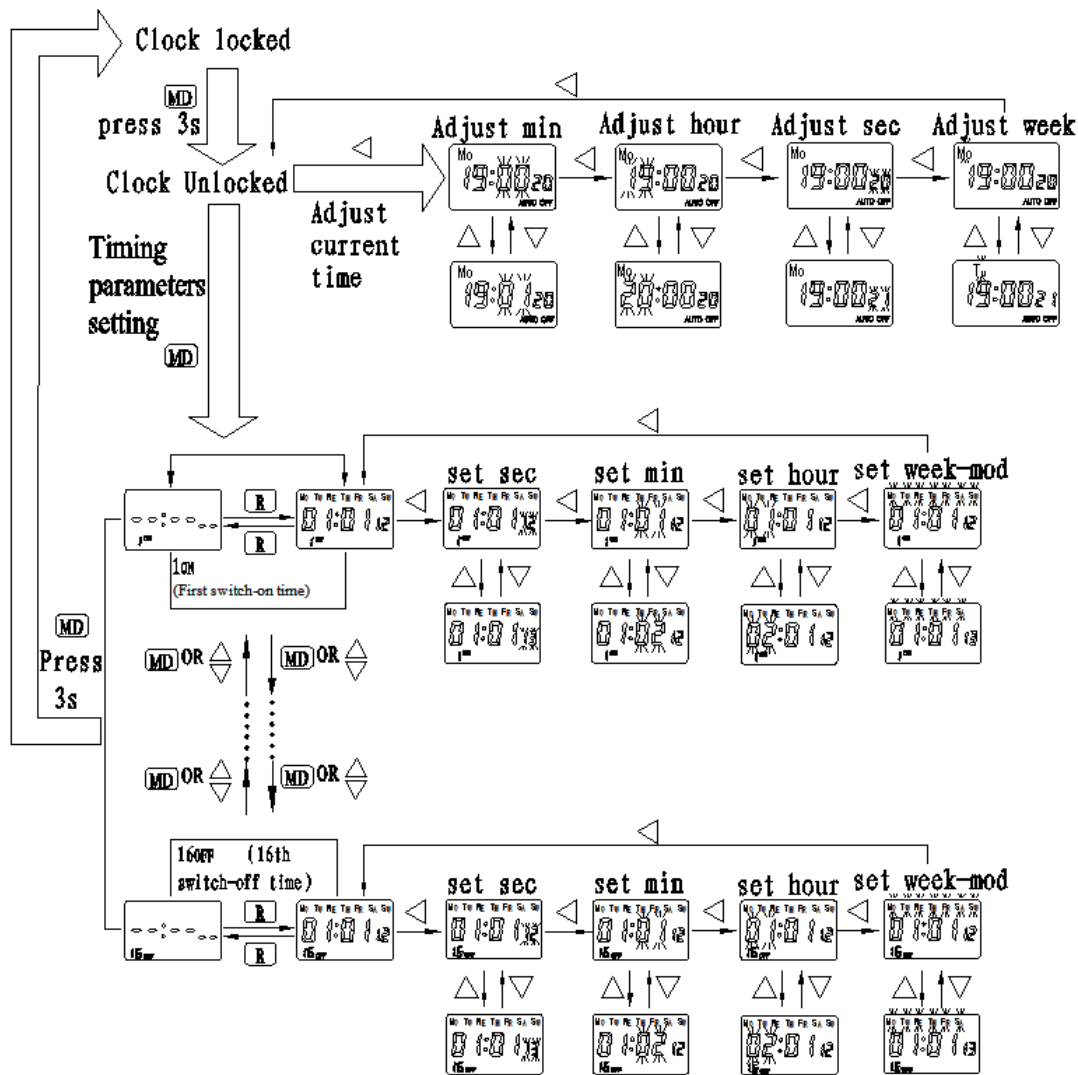

Figure 6 Time switch parameters setting process

6.2 Setting processes are as follows:

6.2.1 Press button “MD” for 3s to cancel the keyboard lockout, so that “LOCK” may disappear, the current “date” flash, you can adjust the date then, see Figure 7.

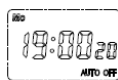

Figure 7

6.2.2 Current date and current time adjustment

6.2.2.1 Press buttons “△” and “▽” respectively to adjust date, for example, if it is Tuesday, you can adjust to “Tu”.

6.2.2.2 Press “MD” to adjust the current time. Press “◀” to select the adjusted position and press “△” and “▽” to plus and minus, so as to adjust the display time to the current time, see Figure 8.

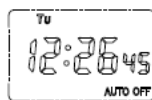

Figure 8

6.2.3 Timing parameters (switch-on/off time) setting

6.2.3.1 After finish operation 6.2.2, press “MD” to set the timing parameters, see Figure 9.

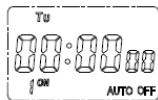

Figure 9

6.2.3.2  $I_{ON}$  (first switch-on) time setting: press “◀”, “▶” and “▽” respectively to set  $I_{ON}$  time and date mode, after setting, press “MD” to enter  $I_{OFF}$  (first switch-off) time and date mode setting, see Figure 10.

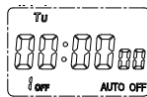

Figure 10

6.2.3.3  $I_{OFF}$  (first switch-off) time and date model setting: set  $I_{OFF}$  time according to steps specified in 6.2.3.2.

6.2.3.4 Continue to press “MD”, the screen will display  $2_{ON}$ ,  $2_{OFF}$  ...  $16_{ON}$ ,  $16_{OFF}$  on the left, set switch time and date model of other groups by referring to the above steps. For redundant time period, please press “R” to remove the time of other groups, so that the liquid-crystal display will show “- - - - -”, see Figure 11, and then, press “R” to recall.

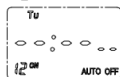

Figure 11

6.2.4 After setting time of each group, press “◀” to set the date. By then, the screen will show Monday to Sunday types and flash, which means the operating time are alike from Monday to Sunday, press “▶” and “▽” to select an operating mode suitable for the user, see Table 2.

Table 2 Operating Mode

SN	Operating Mode	Achieved function
1	M <sub>O</sub> T <sub>U</sub> W <sub>E</sub> T <sub>H</sub> F <sub>R</sub> S <sub>A</sub> S <sub>U</sub>	Operating time is the same every day
2	M <sub>O</sub> T <sub>U</sub> W <sub>E</sub> T <sub>H</sub> F <sub>R</sub> S <sub>A</sub>	Operating time is the same from Monday to Saturday
3	M <sub>O</sub> T <sub>U</sub> W <sub>E</sub> T <sub>H</sub> F <sub>R</sub>	Operating time is the same from Monday to Friday
4	S <sub>A</sub> S <sub>U</sub>	Operating time is the same on Saturday and Sunday
5	M <sub>O</sub> T <sub>U</sub> W <sub>E</sub>	Operating time is the same from Monday to Wednesday
6	T <sub>H</sub> F <sub>R</sub> S <sub>A</sub>	Operating time is the same from Thursday to Saturday
7	M <sub>O</sub> W <sub>E</sub> F <sub>R</sub>	Operating time is the same on Monday, Wednesday and Friday
8	T <sub>U</sub> T <sub>H</sub> S <sub>A</sub>	Operating time is the same on Tuesday, Thursday and Saturday
9	M <sub>O</sub> / T <sub>U</sub> / W <sub>E</sub> / T <sub>H</sub> / F <sub>R</sub> / S <sub>A</sub> / S <sub>U</sub>	Operating time is different every day

6.2.5 After setting, press “MD” for 5s, enter operation state, the time switch locks automatically, “LOCK” shows, and see Figure 12.

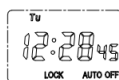

Figure 12

6.3 After locking the switch, press “MD” and “ $\triangle$ ” at the same time to switch manual/automatic status. Continuously press them together, the screen will show “AUTO OFF”, “ON”, “ON AUTO” and “OFF” successively, see Figure 13. When the circuit shall be on and off temporarily in the process of operation, the combination buttons can be used to adjust the switch to ON and OFF; if the time switch shall work automatically according to the set time, the combination button shall be used to adjust the switch to “ON AUTO”, then the time switch may work as set, so as to achieve automatic control.

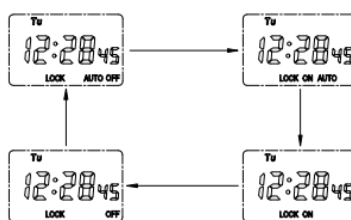

Figure 13

#### 7 Notes

7.1 The switch into the line can only be connected to AC220V power supply, do not access the other power.

7.2 If you can not achieve automatic control function, Check the lower right corner of the screen (AUTO) is right shown?

7.3 The internal battery can only provide the LCD screen display and settings, such as A1, A2 terminal auxiliary power missed, is unable to drive the relay output.

7.4 If the user find errors in the products, Through short 3, 4 terminal reset, After reset procedures need to set again.

7.5 When the end of the product life, please recycle work product or its components, for not recycled parts, please dispose of, to protect our environment.